

# SA-508/HB,HE

## SCHEMATIC DIAGRAM

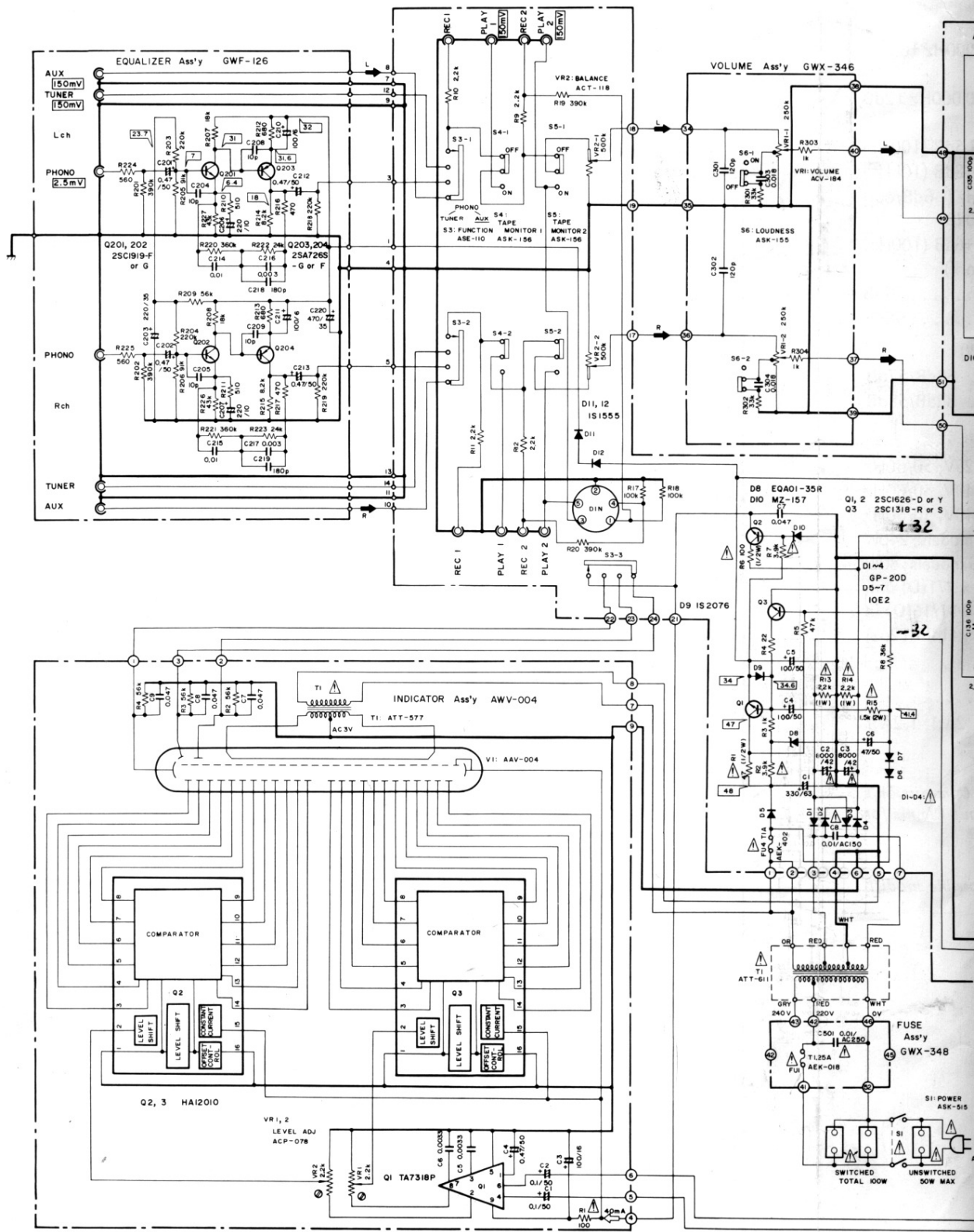

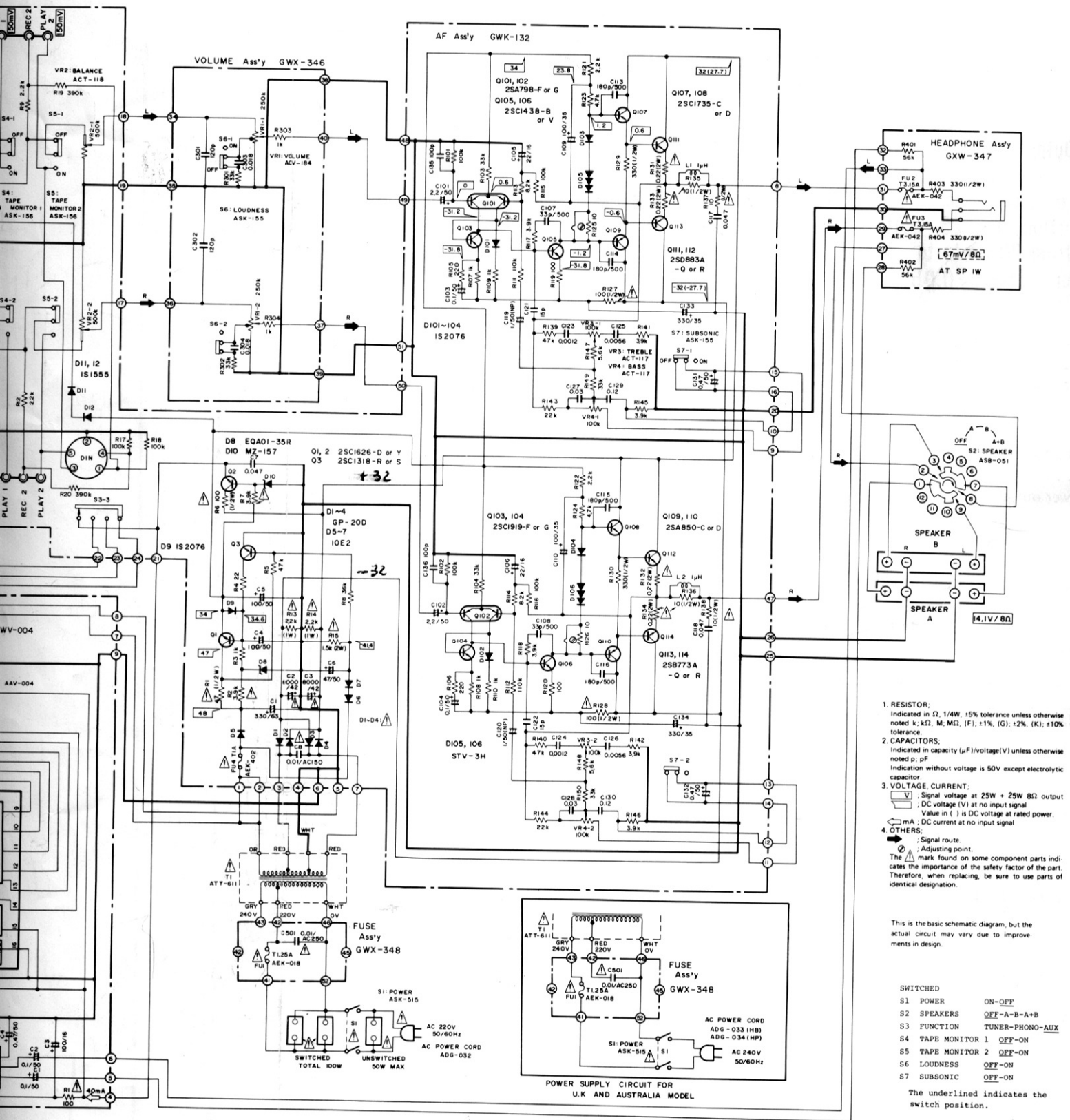

- RESISTOR:**  
Indicated in  $\Omega$ , 1/4W,  $\pm 5\%$  tolerance unless otherwise noted; k: k $\Omega$ , M: M $\Omega$ , (F):  $\pm 1\%$ , (G):  $\pm 2\%$ , (K):  $\pm 10\%$  tolerance.
- CAPACITORS:**  
Indicated in capacity ( $\mu$ F)/voltage (V) unless otherwise noted; p: pF  
Indication without voltage is 50V except electrolytic capacitor.
- VOLTAGE, CURRENT:**  
V: Signal voltage at 25W + 25W 8 $\Omega$  output  
DC voltage (V) at no input signal  
Value in ( ) is DC voltage at rated power.  
mA: DC current at no input signal
- OTHERS:**  
Signal route  
Adjusting point  
mark found on some component parts indicates the importance of the safety factor of the part. Therefore, when replacing, be sure to use parts of identical designation.

This is the basic schematic diagram, but the actual circuit may vary due to improvements in design.

# SPECIFICATIONS

## Semiconductors

ICs . . . . .	3
Transistors . . . . .	21
Diodes . . . . .	18

## Amplifier Section

Continuous Power Output of 25 watts\* per channel, min., at 8 ohms from 20 Hertz to 20,000 Hertz with no more than 0.03% total harmonic distortion or 25 watts per channel at 4 ohms from 20 Hertz to 20,000 Hertz with no more than 0.05% total harmonic distortion.

Continuous Power Output at 1kHz (both channels driven)	
T.H.D. 0.03%, 8 ohms . . . . .	28 watts per channel
Total Harmonic Distortion (20 Hertz to 20,000 Hertz, 8 ohms, from AUX)	
continuous rated power output . . . . .	No more than 0.03%
12.5 watts per channel power output . . . . .	No more than 0.03%
1 watt per channel power output . . . . .	No more than 0.03%
Intermodulation Distortion (50 Hertz: 7,000 Hertz = 4:1, 8 ohms, from AUX)	
continuous rated power output . . . . .	No more than 0.03%
12.5 watts per channel power output . . . . .	No more than 0.03%
1 watt per channel power output . . . . .	No more than 0.03%
<b>Damping Factor (1,000 Hertz, 8 ohms) . . . . .</b>	<b>30</b>

### Input (Sensitivity/Impedance)

PHONO . . . . .	2.5mV/47kilohms
TUNER . . . . .	150mV/50kilohms
AUX . . . . .	150mV/50kilohms
TAPE PLAY 1 . . . . .	150mV/50kilohms
TAPE PLAY 2 . . . . .	150mV/50kilohms
TAPE PLAY 2 (DIN connector; HB, HE, HP models) . . . . .	150mV/50kilohms

### Phono Overload Level (T.H.D. 0.1% 1,000Hz)

PHONO . . . . .	140mV
-----------------	-------

### Output

TAPE REC 1 . . . . .	150mV
TAPE REC 2 . . . . .	150mV
TAPE REC 2 (DIN connector; HB, HE, HP models) . . . . .	30mV/80kilohms
Speaker . . . . .	A, B, A+B 4~16 ohms

## Frequency Response

### PHONO (RIAA Equalization)

. . . . . 30Hz to 15,000Hz  $\pm$ 0.5dB

### TUNER, AUX, TAPE PLAY

. . . . . 20Hz to 40,000Hz  $\pm$ 2dB

## Tone Control

BASS . . . . . +7.5dB, -7.5dB (100Hz)

TREBLE . . . . . +8dB, -8dB (10kHz)

Subsonic Filter . . . . . 15Hz (-6dB/oct)

Loudness Contour (Volume control set at -40dB

position) . . . . . +6dB (100Hz)

Hum and Noise (IHF, short-circuited, A network)

PHONO . . . . . 76dB

TUNER, AUX, TAPE PLAY . . . . . 98dB

Hum and Noise (DIN continuous power/50mW)

PHONO . . . . . 68dB/57dB

TUNER, AUX, TAPE PLAY . . . . . 82dB/58dB

## Miscellaneous

Power Requirements . . . . . HE model; AC220V, 50/60Hz

HB, HP models; AC240V, 50/60Hz

S, S/G models; AC110V/120V/220V/240V, 50/60Hz

Power Consumption . . . . . HE, HB, HP models; 240W

S, S/G models; 80W

Dimensions . . . . . 420(W) x 150(H) x 271(D) mm

16-9/16(W) x 5-7/8(H) x 10-11/16(D) in

Weight (without package) . . . . . 6.7 kg (14lb 12oz)

## Furnished parts

Operating instructions . . . . . 1

Fuse (S, S/G models only) . . . . . 2A;1, 1.2A;1

\* Measured pursuant to Federal Trade Commission's Trade Regulation rule on Power Output Claims for Amplifiers.

### NOTE:

Specifications and the design subject to possible modification without notice due to improvements.

STEREO AMPLIFIER

PIONEER

# SA-508

HB  
HP, HE  
S

## OPERATING INSTRUCTIONS

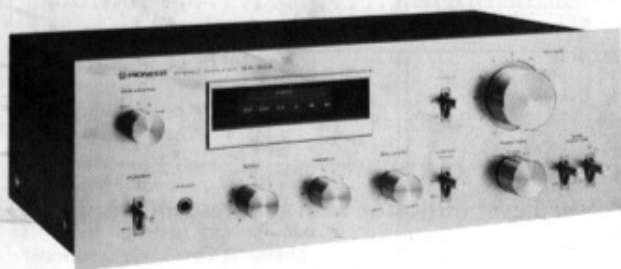

The specifications of this model differ according to the shipment destination.

- For U.K. ('HB' stamped on packing case): Power line voltage is 240 volts.  
A DIN socket is provided on the rear panel.
- For Australia ('HP' stamped on packing case): Power voltage is 240 volts.  
A DIN socket is provided on the rear panel.
- For mainland Europe ('HE' stamped on packing case): Power line voltage is 220 volts.  
AC convenience outlets are provided on the rear panel, and a DIN socket is provided on the rear panel.
- For destinations excluding above ('S' stamped on packing case): A 4-point (110V/120V/220V/240V) voltage selector switch is provided on the rear panel, and AC outlets are provided on the rear panel.

**NOTE:**

Models for the U.K. ('HB'), Australia ('HP') and mainland Europe ('HE') have their power line voltages set in accordance with their destination before they are shipped from the factory. The voltage which has thus been set is indicated on the rear panel of the main unit.

Before switching on the power, make absolutely sure that the voltage tallies with the value used in your area. If it does not tally or if you move to another area with a different voltage (such from 220V to 240V or vice versa), get in touch with your nearest authorized Pioneer Service Center or Service Station or, alternatively, call for a qualified electrician to set the voltage properly.

### IMPORTANT

*To prevent electric shock, do not remove cover. No user serviceable parts inside, refer servicing to qualified service personnel.*

*Always disconnect all the equipment from the mains supply when disconnecting the signal leads. The power cord should be connected last, make sure that the power switch is off.*

*Unplug the set from the wall socket when it is not to be used for an extended period of time.*

#### FOR USE IN UNITED KINGDOM AND AUSTRALIA

**CAUTION 240V: Mains supply voltage is factory adjusted at 240V.**

#### FOR USE IN UNITED KINGDOM

*The wires in this mains lead are coloured in accordance with the following cord:*

Blue:	Neutral
Brown:	Live

*As the colours of the wires in the mains lead of this apparatus may not correspond with the coloured marking identifying the terminals in your plug proceed as follows.*

*The wire which is coloured blue must be connected to the terminal which is marked with the letter N or coloured black.*

*The wire which is coloured brown must be connected to the terminal which is marked with the letter L or coloured red.*



## CONTENTS

Features .....	2	Operations .....	10
Stereo System Composition .....	3	Using the Tape Decks .....	11
Installation Precautions .....	3	Conditions Frequently Mistaken for Malfunctions .....	12
Rear Panel Facilities .....	4	Specifications .....	Insertion
Connections .....	5	Schematic Diagram .....	Insertion
Front Panel Facilities .....	8		

## FEATURES

### Power Amplifier Section that Packs a Consistently Stable Power Punch

The power amplifier section adopts a single-stage differential amplifier with a current mirror load, all-stage direct-coupled pure complementary OCL circuit. In particular, the first stage has a differential amplifier circuit with dual transistors to keep down the fluctuations in the characteristics such as temperature variations to bare minimum. A current mirror load is featured in this differential amplifier circuit which paves the way to a high amplification design. This generates a high level of negative feedback and assures the reproduction of a **Continuous Power Output of 25 watts\* per channel, min., at 8 ohms from 20 Hertz to 20,000 Hertz with no more than 0.03 % total harmonic distortion.**

### Phono Circuitry with Plenty of Leeway in the S/N and Other Characteristics

The low-noise transistors and low noise elements combine to produce a signal-to-noise ratio (PHONO) of 76dB (IHF-A). As a result, the RIAA deviation, which has a great bearing on the sound quality, is improved to  $\pm 0.5$ dB (over 30 to 15,000Hz), and the phono overload level is 140mV (1kHz, T.H.D. 0.1%) with respect to a 2.5mV rating. This is, then, a design which has plenty to spare and which permits the almost distortion-free play of records on your turntable for the best in high-fidelity.

### Power Level Indicator with Fluorescent Display Tubes

Use for the power level indicator are two fluorescent display tubes (one for the left channel and the other for the right) which feature a very fast response speed to indicate the power level virtually instantaneously. This indicator is composed of highly dependable ICs and its logarithmic compression and drive circuits make it possible for a wide range of power levels from 0.01W right up to the maximum levels to be indicated for both the left and right channels independently without switching knobs or levers.

### Rich Store of Accessory Functions

- The subsonic filter switch serves to cut out the low-frequency noise, which is harmful to your speakers, generated by record warp.
- The loudness switch compensates for the deficiencies of the human ear with respect to low-frequency sound and it is also useful when listening to programs at night, for instance, with the sound turned down.
- The function indicators tell you the program source at a glance.
- The amplifier is provided with **two sets (A and B) of speaker terminals** so that you can connect two sets of speaker systems. This means that you can listen to the program on one set in another room.
- The amplifier is also equipped with **two sets of tape deck jacks** for connecting two tape decks. The tape monitor switches can be used to dub tapes from TAPE 1 deck to TAPE 2 deck and for simple tape editing.

# STEREO SYSTEM COMPOSITION

## Shelves

Make sure that the shelves are stable and fully capable of supporting heavy weights and resisting vibration.

## Turntable

- Set the turntable so that it is not affected by vibration.
- Keep the dust cover closed as much as possible.

## Audio rack

- Stack the records up for storage — do not lay them flat.
- Do not expose pre-recorded tapes near the stereo system for long periods of time.
- Do not store the tapes anywhere near a magnetic field.

The sound quality sometimes changes depending on the position and the material of the furniture.

## Connecting the speakers

Use high current capacity connecting cords and do not make them longer than necessary.

## Carpet

Carpets on the floor help to absorb the sound.

Listening position is slightly to the apex of an equilateral triangle formed with left and right speakers.

## Installing the stereo amplifier

- Choose a location where the heat will be dissipated easily.

## Tuner

- Do not make the connecting cords longer than necessary.
- Set the antenna in the direction best suited for reception.
- Use an external antenna for FM reception.

## Tape deck

- Make sure you clamp the reels when using the tape deck.

## Thick curtains

- Use curtains to shade the stereo system from the direct rays of the sun.
- Curtains also help to reduce resonance and reverberation in the listening room.

## Speaker system

- Install the speakers to the left and right so that they are subject to the same conditions both to the side and at the back. (The bass is more pronounced if you set them up against a wall.)
- Install the speakers so that they are not affected by vibration transmitted through the floor.

# INSTALLATION PRECAUTIONS

To ensure the best sound quality and trouble-free operation, avoid setting up the amplifier in any of the locations described below:

Locations liable to downgrade performance and result in breakdowns	Resulting trouble
<ol style="list-style-type: none"> <li>1. Locations exposed to direct sunlight, or near heaters.</li> <li>2. Locations with poor ventilation, with high humidity or moisture contents, or dusty locations.</li> <li>3. Locations susceptible to vibration.</li> </ol>	<ol style="list-style-type: none"> <li>1. External heat causes the performance of the electronic parts to deteriorate, and operation becomes unstable.</li> <li>2. Cause of faulty contact in input-output terminals, and rust. High humidity and a high moisture content cause deterioration in insulation. There is also the danger of current leakage and heat generation in the circuit parts. Dust or grease in the rotating parts causes them to deteriorate.</li> <li>3. These locations affect the precision parts adversely.</li> </ol>

## REAR PANEL FACILITIES

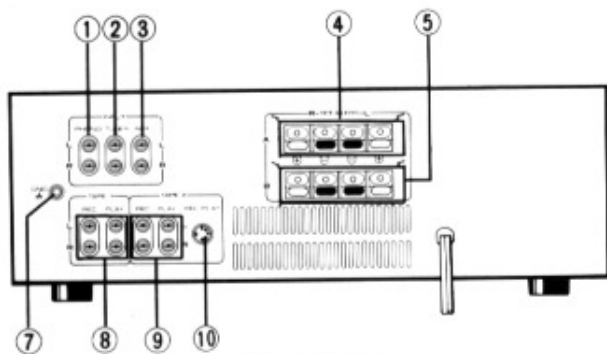

HB, HP models

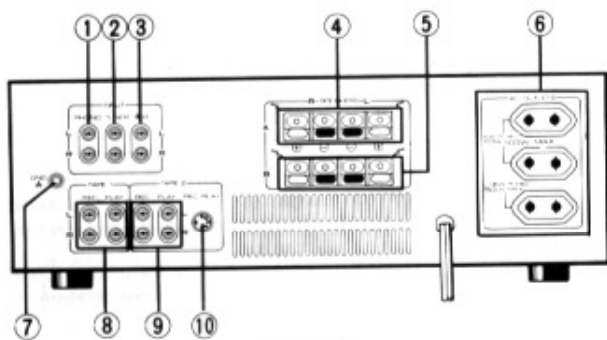

HE model

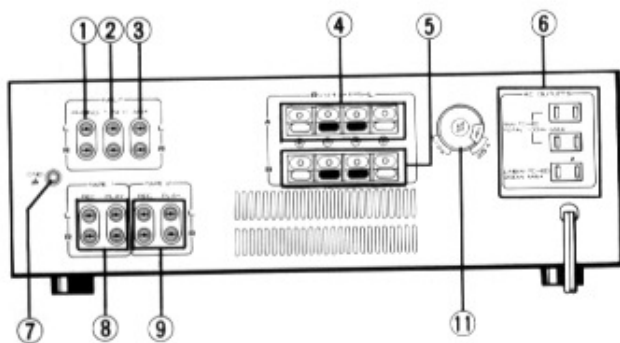

S model

### ① PHONO JACKS

Connect the turntable output cords to these jacks.

### ② TUNER JACKS

Connect the tuner cords to these jacks.

### ③ AUX JACKS

These are auxiliary input jacks. Connect a TV tuner or cartridge tape player to them.

### ④ SPEAKERS TERMINALS A

Connect your first pair of speakers to these terminals.

### ⑤ SPEAKERS TERMINALS B

Connect your second pair of speakers to these terminals.

### ⑥ AC OUTLETS (HE, S models only)

These are spare power outlets. Insert the power plug on the stereo components (turntable, tuner, tape deck, etc.) into these outlets.

**SWITCHED:** The power supplied through these outlets is coupled to the operation of the amplifier's power switch.

**UNSWITCHED:** The power is always supplied through this outlet regardless of the position of the power switch.

The maximum power capacity of the AC OUTLETS

	S model	HE model
SWITCHED	100W	100W
UNSWITCHED	200W	50W

#### NOTES:

- Never connect the power plug of the electric appliances whose power consumption exceeds the power capacity of the AC OUTLETS indication.
- Never connect an iron or a toaster to these outlets.
- Do not get the power outlets and the power plugs wet or touch them with wet hands, since you may get an electric shock.

### ⑦ GND TERMINAL

This is the ground terminal. Connect the ground wire of the turntable, etc. to this terminal.

### ⑧ TAPE 1 JACKS

Connect the tape deck cords to these jacks. Connect the REC (recording) jacks to the INPUT jacks on the tape deck, and the PLAY (playback) jacks to the OUTPUT jacks.

### ⑨ TAPE 2 JACKS

Connect your second tape deck cords to these jacks. Connect the REC (recording) jacks to the INPUT jacks on the tape deck, and the PLAY (playback) jacks to the OUTPUT jacks.

### ⑩ TAPE 2 JACK (HB, HE models only)

Connect the tape deck to this jack with DIN-type (recording/playback) cord.

① LINE VOLTAGE SELECTOR SWITCH (S model only)

Check that the indication of the switch is same as your residence before plugging the power cord into the outlet. If it isn't or if you move to an area where the voltage requirements differ, change the switch setting as follows.

Before adjusting, disconnect the power cord.

1. Unscrew the fuse cap with a Phillips screwdriver, then take out the fuse and plug.
2. Re-install the plug with its cutaway section exposing the correct voltage indication as shown in Fig. A.
3. Refer to the table and install a replacement fuse (provided as an accessory).
4. Insert the fuse in the fuse cap, then fit the cap to the plug and tighten.

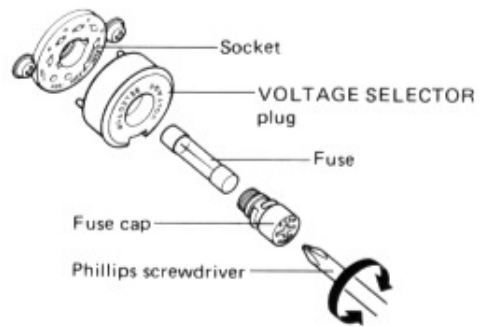

Table

Voltage	Fuse
110V, 120V	2A
220V, 240V	1.2A

Fig. A

CONNECTIONS

CONNECTION DIAGRAM

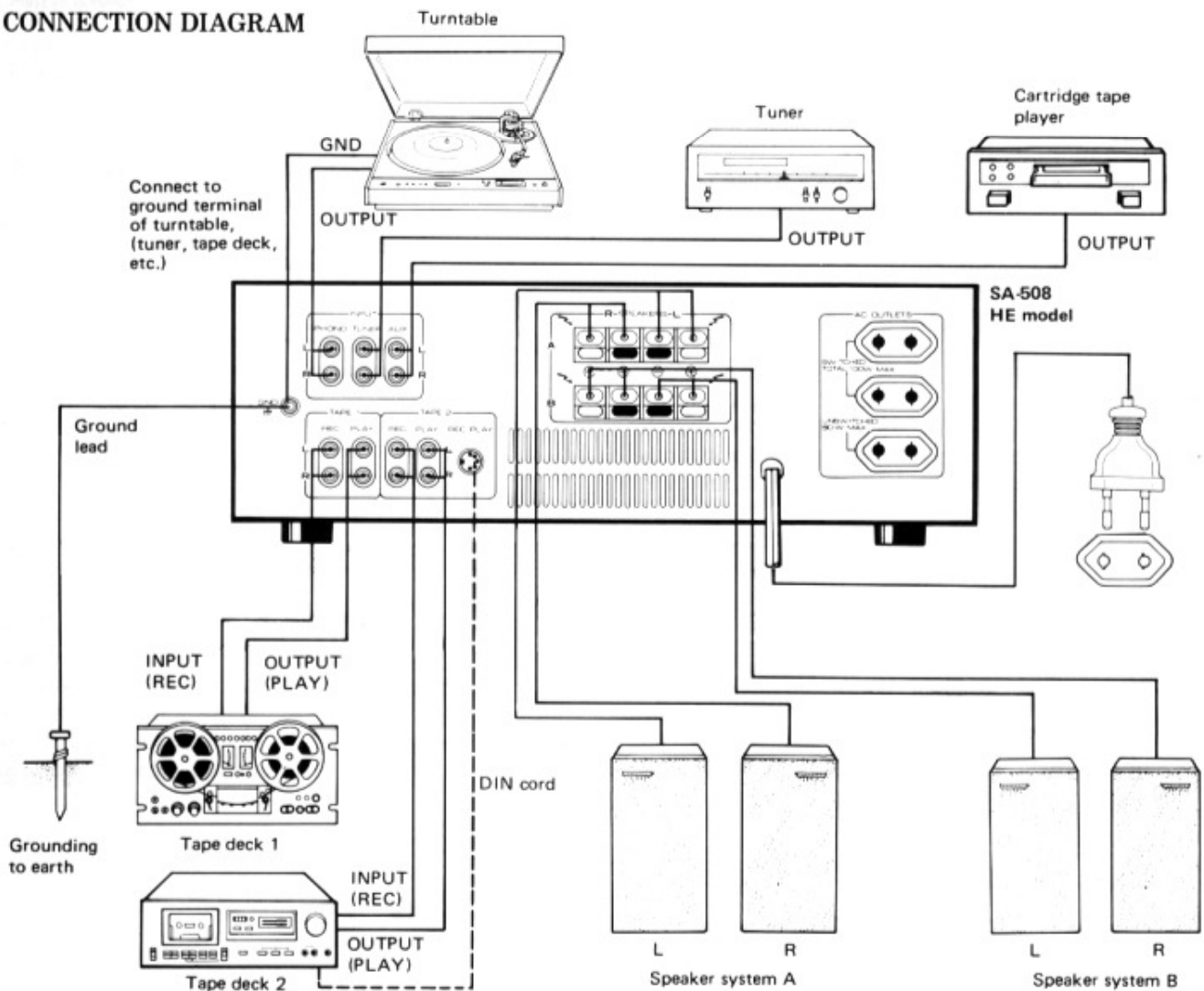



## SPEAKER SYSTEM CONNECTIONS (Fig. 1)

The amplifier is provided with two sets of SPEAKERS output terminals. Use the A set when connecting only one set of speakers. Viewed from the front, the R (right channel) SPEAKERS terminals are on the right and the L (left channel) SPEAKERS terminals are on the left. Connect the left channel speaker to the L terminals and the right channel speaker to the R terminals. The red L and R SPEAKERS terminals have a plus polarity and the black terminals have a minus polarity and the speaker systems have also the same dual polarities. When connecting, always connect minus to minus and plus to plus.

### Cautions when connecting the speakers

1. The speaker output terminals have polarities: minus (black) and plus (red). The input jacks on the speakers also have plus and minus polarities. When connecting, make sure that these polarities are aligned: plus to plus and minus to minus. If the left and right speaker polarities are misaligned, the reproduced sound will not display a natural stereo effect.
2. Use speakers with a nominal impedance ranging from 4 ohms to 16 ohms.
3. Never use the speakers with the speaker output terminals shorted (minus and plus jacks connected) since this may damage the power transistors in the amplifier.

### Processing and connecting the speaker cords (Fig. 2-① ~ ③)

1. Cut off the covering of the speaker cords.
2. If the strands at the tip of the cord are pointing in all directions, twist them with your thumb and forefinger. Otherwise some of the strands may come into contact with other terminals and cords, and cause a short.
3. Push down on the buttons under the terminals with the tip of your finger, and slip the tip of the cord into the hole in the center of the terminal. Make sure that the lead wire in the cord does not protrude.
4. Remove your fingertip from the button. The terminal will snap back into position and so check that the cord is securely connected. You may not hear any sound if the cords are not connected properly.

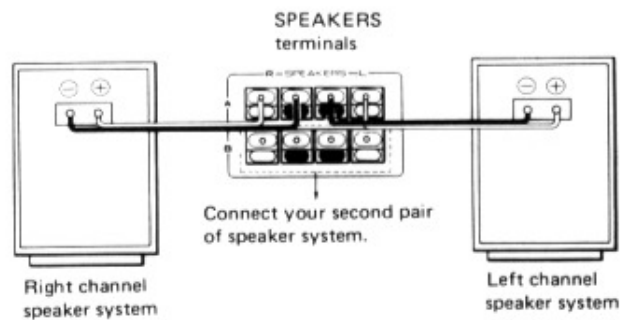

Fig. 1

### Speaker lead wire preparation and connection

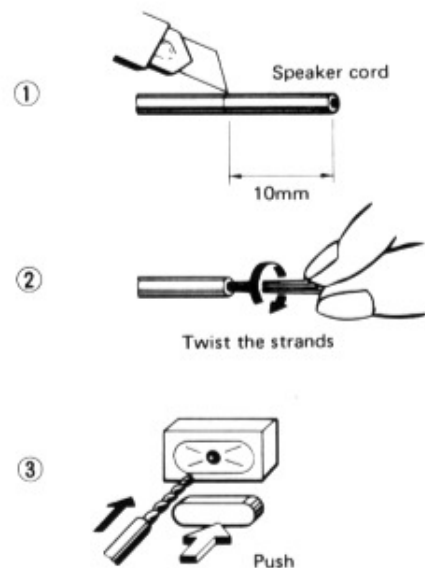

Fig. 2

**TURNTABLE CONNECTIONS (Fig. 3)**

Connect the output cords of a turntable to the PHONO input jacks. Connect the ground lead of the turntable to the GND terminal on the amplifier.

**NOTE:**

*The way in which the output cords are attached will depend on the type of cartridge used. If you intend to use a low-output moving coil (MC) cartridge, always provide a special MC transformer or a head amplifier.*

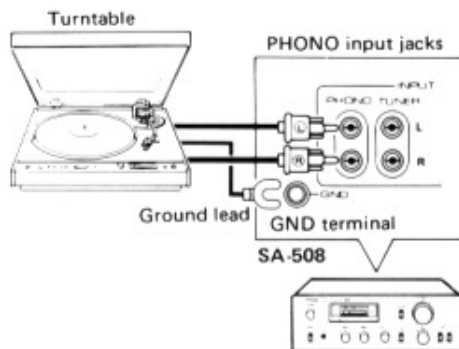

Fig. 3

**TUNER CONNECTIONS (Fig. 4)**

Connect the output jacks of a stereo tuner to the TUNER input jacks with the connecting cords.

**AUX JACKS CONNECTIONS (Fig. 5)**

These jacks can be connected to the OUTPUT (PLAY) jacks on a TV tuner, cartridge tape player or tape deck. Use connecting cords with pin plugs to connect the OUTPUT jacks on the component with the AUX jacks.

**TAPE DECK CONNECTIONS (Fig. 6)**

This amplifier is provided with two sets of recording (TAPE REC) output jacks and two sets of playback (TAPE PLAY) input jacks. Connect each of the jacks in the following way using the connecting cords which come with the tape deck.

**Connections for recording**

Connect the recording input jacks (INPUT) on the tape deck to the TAPE REC jacks on the amplifier.

**Connections for playback**

Connect the playback output jacks (OUTPUT) on the tape deck to the TAPE PLAY jacks on the amplifier.

**NOTE:**

*Connect your second tape deck to the TAPE 2 jacks (REC, PLAY).*

**Connections using the recording/playback connector (Applicable to HB, HP, HE models)**

If your tape deck is equipped with a recording/playback connector (DIN-type), use the optional recording/playback cord to connect this connector with the TAPE 2 REC/PLAY jack on the amplifier. In such cases, do not connect pin cords (ordinary pin plug cords) to the TAPE 2 REC and PLAY jacks.

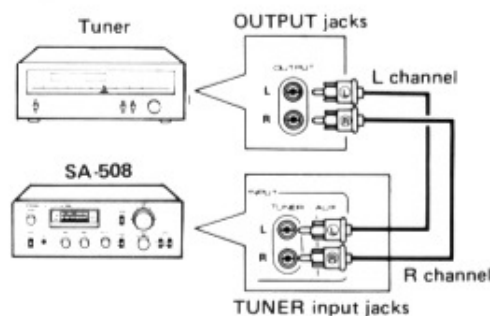

Fig. 4

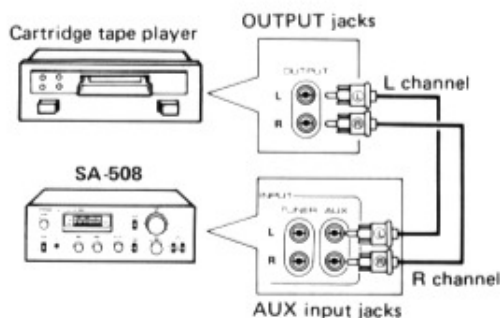

Fig. 5

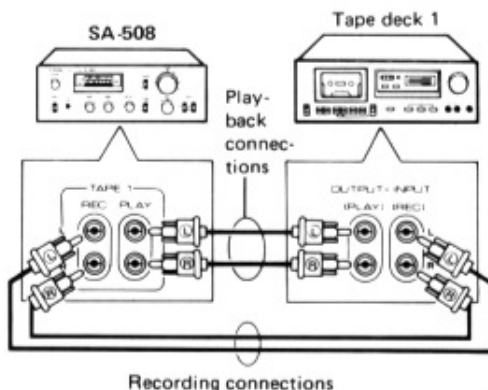
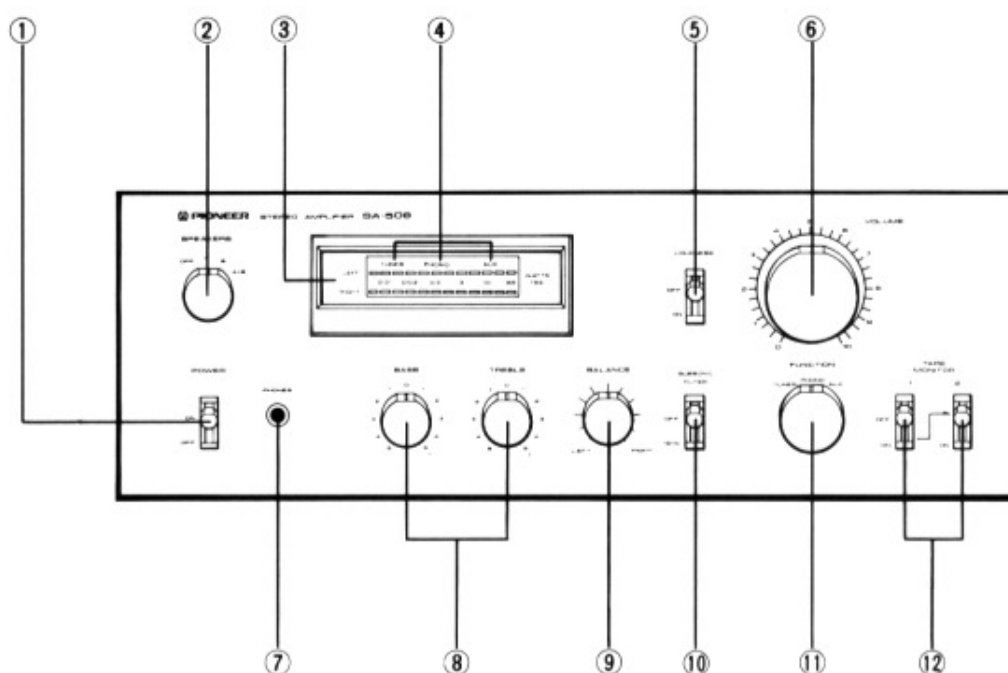

Fig. 6

## FRONT PANEL FACILITIES



### ① POWER SWITCH

Set this switch to ON to supply power to the amplifier.

### ② SPEAKER SELECTOR

Use this selector to select the speaker systems.

OFF: Sound not obtained from speakers.

A: Sound obtained from speakers connected to the A speaker terminals.

B: Sound obtained from speakers connected to the B speaker terminals.

A+B: Sound obtained from speakers connected to both A and B speaker terminals.

### ③ POWER METER

This meter allows you to read out the rated power level on the fluorescent display tube when speakers with a nominal impedance of 8 ohms are connected to the amplifier's speaker terminals.

### ④ FUNCTION INDICATORS

The TUNER, PHONO, AUX function indicators light up in accordance with the position of the function selector.

*NOTE:*

*The function indicator will not go off even when the tape monitor switch 1 or 2 is set to ON.*

### ⑤ LOUDNESS SWITCH

When listening to a performance with the volume control turned down, set this switch to ON and the bass will be accentuated.

When the volume is low, the human ear finds it harder to hear the bass than when the volume is high. The loudness switch is thus designed to compensate for this deficiency. By setting it to ON, the bass comes through much more strongly and the sound takes on a punch even when the volume control is turned down.

**⑥ VOLUME CONTROL**

Use this control to adjust the output level to the speakers and headphones. Turn it clockwise to increase the output level. No sound will be heard if you set it to "0".

**⑦ HEADPHONE JACK**

Plug the headphones into this jack when you want to listen through your stereo headphones.

*NOTE:*

Set the speaker selector to OFF when listening only with headphones.

**⑧ BASS AND TREBLE CONTROLS**

Use these controls to adjust the bass and the treble. If you turn the bass control to the right from its center position, you will be able to emphasize the sound in the low-frequency range. Conversely, turning this control left from the center position, you will attenuate the sound. You can use the treble control to adjust the sound in the high-frequency range.

**⑨ BALANCE CONTROL**

Use this control to balance the volume of the left and right channels. If the sound appears to be louder on the right, it means that the volume of the right channel is higher. Turn the balance control to the left and adjust.

Conversely, if the sound appears to be louder on the left, it means that the volume of the left channel is higher. Therefore, turn the balance control to the right and adjust.

**⑩ SUBSONIC FILTER SWITCH**

When this switch is set to the 15Hz position, the subsonic filter with a cut-off frequency of 15Hz is actuated. The subsonic filter serves to attenuate frequencies lower than 15Hz in a 6dB/oct slope. It is therefore effective in suppressing ultra-low-frequency noise which is generated by record warp and other causes. You cannot actually hear this noise but it is a factor in the generation of intermodulation distortion and it may damage your speaker system. Set this switch to the 15Hz position during record play for the best effect.

**⑪ FUNCTION SELECTOR**

Use this selector to select the program source. When set, the function indicator above the meter panel corresponding to the position of the function selector will light up.

**TUNER:** Set here when listening to broadcasts on a tuner connected to the TUNER jacks. (The TUNER function indicator lights up.)

**PHONO:** Set here when playing records on a turntable connected to the PHONO jacks. (The PHONO function indicator lights up.)

**AUX:** Set here when listening to a program source which is connected to the AUX jacks.

(The AUX function indicator lights up.)

**⑫ TAPE MONITOR SWITCHES (1, 2)**

Use these switches to monitor recording or a tape being played back on a tape deck.

1: Set this switch to ON when you want to monitor a recording or a tape being played back on a tape deck which is connected to the TAPE 1 jacks.

2: Set this switch to ON when you want to monitor a recording or a tape being played back on a tape deck which is connected to the TAPE 2 jacks.

*NOTE:*

Set these switches to the upper (OFF) position when playing records or listening to broadcasts.



## OPERATIONS

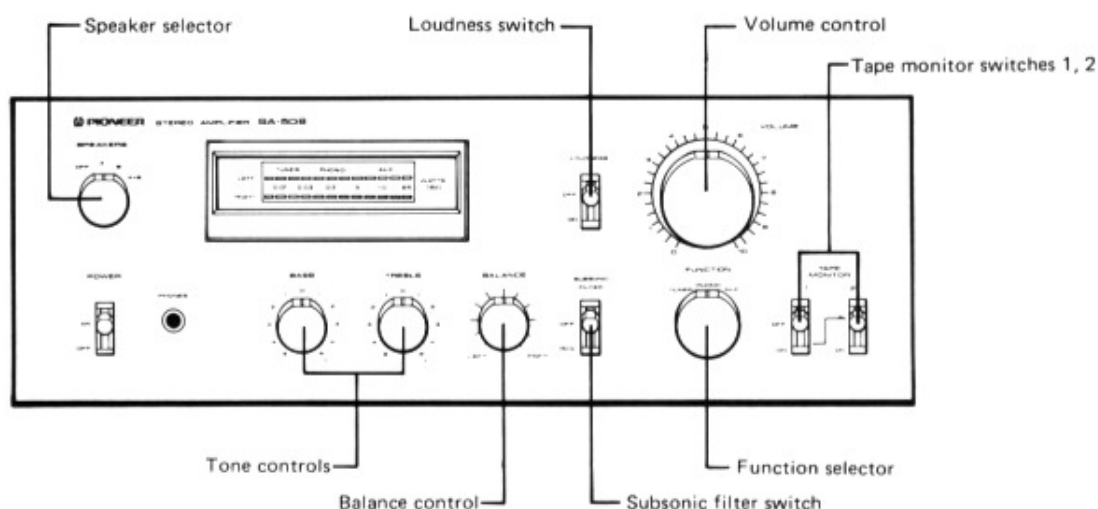

### PRIOR TO SWITCHING POWER ON

Before switching the power on, set the various controls as follows:

1. Set the subsonic filter switch to OFF.
2. Set the volume control to 0.
3. Set the both tape monitor switches to OFF.
4. Set the balance control to the center position.
5. Set the loudness switch to OFF.
6. Set the tone controls to the center positions.
7. Set the speaker selector to the appropriate position according to the employed terminals.

### PLAYING RECORDS

1. Set the function selector to PHONO.
2. Operate the turntable to play the record.
3. Adjust the volume with the volume control.
4. Set the bass and treble controls for the preferred bass and treble levels.

### Precautions when playing records.

- Lower the stylus gently on to the surface of the record. It is a good idea to turn the volume down when lowering the stylus onto the record.
- Set the subsonic filter switch to 15Hz when there is a great deal of noise in the low-frequency region or when the bass speaker's diaphragm moves even though no sound can be heard during a performance.

- Do not cause the turntable to vibrate while a record is being played since this will cause the stylus to jump and scratch the record. Do not turn off the power if the stylus is still tracing grooves on the record.

### LISTENING TO THE BROADCAST

1. Set the function selector to TUNER.
2. Operate the tuner and tune in to the desired station.
3. Adjust the volume with the volume control.
4. Set the bass and treble controls for the preferred bass and treble levels.

### USING THE AUX JACKS

1. Set the function selector to AUX.
2. Operate the audio component which you have connected to the AUX jacks.
3. Adjust the volume with the volume control.
4. Set the bass and treble controls for the preferred bass and treble levels.

## USING THE TAPE DECKS

### PLAYBACK

1. As shown in Fig. 7, set the tape monitor switch 1 to ON if the tape deck is connected to the TAPE 1 jacks. Set the tape monitor switch 2 to ON if it is connected to the TAPE 2 jacks.
2. Operate the tape deck controls for playback.
3. Adjust the volume with the volume control.
4. Set the bass and treble controls for the preferred bass and treble levels.

#### NOTES:

1. Always return both of the tape monitor switches to the upper position (OFF) when you are not playing back a tape.
2. As long as the tape monitor switch 1 or 2 is at ON, you will be able to play back a tape regardless of the setting of the function selector.

### RECORDING

1. Set the function selector to the program source to be recorded.
2. Play the selected program source.
3. Set recording level by means of the controls on the tape deck. During recording, the volume, bass, and treble controls of the amplifier have no effect on the recording level.
4. Operate the tape deck controls and start recording.

### TAPE MONITORING

If a recording is being made on a 3-head tape deck, the recorded sound can be monitored through the speaker system if the tape monitor switch 1 or 2 is set to ON. In this case, both recording and playback connections must be made.

#### NOTE:

If you have a 2-head open-reel deck or cassette deck, you will not be able to monitor the recorded sound even if you set the tape monitor switch to ON. However, you will be able to hear the sound at the playback end (program source).

### DUPLICATING AND EDITING RECORDED TAPES

1. As shown in Fig. 9, connect the tape deck for the amplifier's TAPE 1 and TAPE 2 jacks.
2. Playback the recorded tape on tape deck 1 and set the tape monitor switch 1 to ON.
3. Operate the controls on tape deck 2 and start recording.
4. Set the tape monitor switch 2 to ON when you want to monitor the recorded sound.

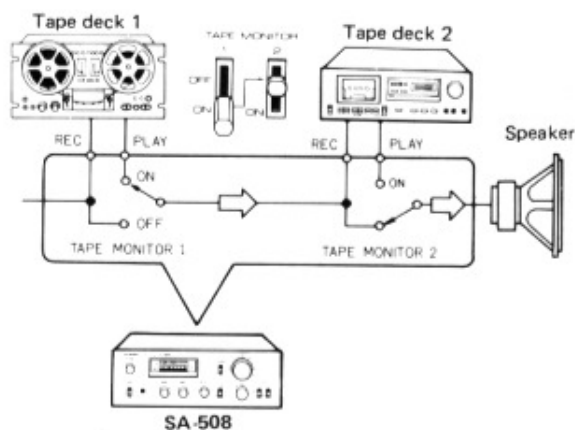
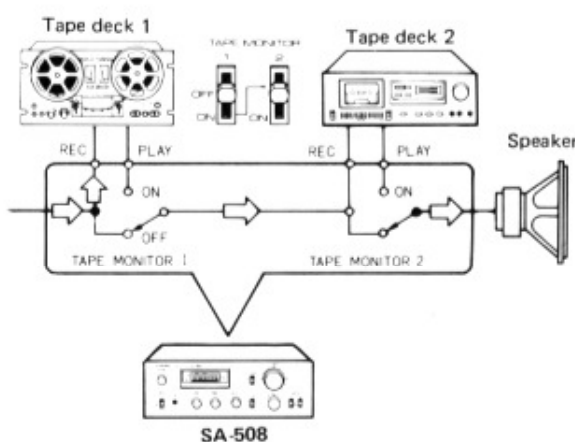

Fig. 7



#### NOTE:

When recording with two tape decks simultaneously, do not operate the tape monitor 1 switch as this will interrupt the signal to the TAPE 2 deck (see Fig. 8).

Fig. 8

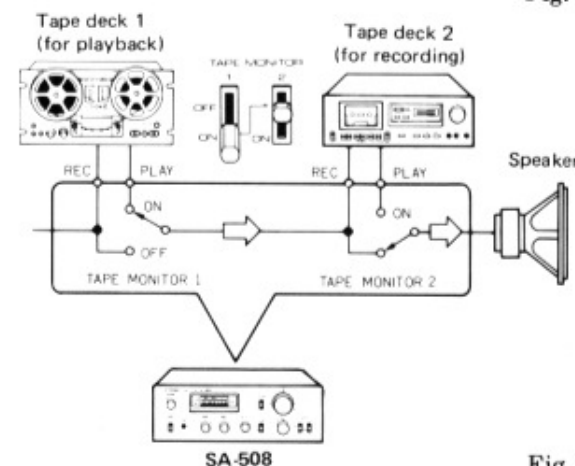

Fig. 9

#### NOTE:

It is impossible to duplicate from the tape deck connected to the TAPE 2 jacks to the tape deck connected to the TAPE 1 jacks.

## CONDITIONS FREQUENTLY MISTAKEN FOR MALFUNCTIONS

In event of suspected malfunction, check the unit according to the following table and confirm proper operation of other connected equipment. If the difficulty cannot be corrected, turn off the power and contact a Pioneer authorized service center.

Symptom	Diagnosis check points	Remedy
No sound	<ul style="list-style-type: none"> <li>Does power indicator light on?</li> </ul>	<ul style="list-style-type: none"> <li>Plug power cord securely into power outlet.</li> <li>Set power switch to ON.</li> </ul>
	<ul style="list-style-type: none"> <li>Are speakers, tuner, tape deck and other components connected properly?</li> </ul>	<ul style="list-style-type: none"> <li>Connect properly. (If all components are connected properly, check the components themselves).</li> </ul>
	<ul style="list-style-type: none"> <li>Is function selector set to correspond to program source?</li> </ul>	<ul style="list-style-type: none"> <li>Set so that the switch corresponds to the source.</li> </ul>
	<ul style="list-style-type: none"> <li>Check tape monitor switch position.</li> </ul>	<ul style="list-style-type: none"> <li>Set to OFF except for tape playback. Refer to page 11.</li> </ul>
	<ul style="list-style-type: none"> <li>Check speaker selector position.</li> </ul>	<ul style="list-style-type: none"> <li>Select in accordance with the speaker terminals to which speakers are connected.</li> </ul>
	<ul style="list-style-type: none"> <li>Check volume control.</li> </ul>	<ul style="list-style-type: none"> <li>Rotate volume control clockwise.</li> </ul>
Occasionally noise is heard.	<ul style="list-style-type: none"> <li>Are components connected properly?</li> </ul>	<ul style="list-style-type: none"> <li>Connect to as to eliminate faulty contacts. (Noise may decrease when ground wire is connected.)</li> </ul>
	<ul style="list-style-type: none"> <li>Any problem with connected components?</li> </ul>	<ul style="list-style-type: none"> <li>Correct fault.</li> </ul>
Howl caused when volume is raised.	<ul style="list-style-type: none"> <li>Turntable and speakers are too close to one another.</li> </ul>	<ul style="list-style-type: none"> <li>Try changing the installation locations of the turntable and speakers.</li> </ul>
	<ul style="list-style-type: none"> <li>Installation locations of turntable and speakers are not stable.</li> </ul>	<ul style="list-style-type: none"> <li>Do not turn up the bass controls excessively.</li> </ul>